

KONICA MINOLTA

AccurioPress
7136/7136P/7120

KEEP YOUR BUSINESS IN THE BLACK

RETHINK MONOCHROME
PRINT PRODUCTION

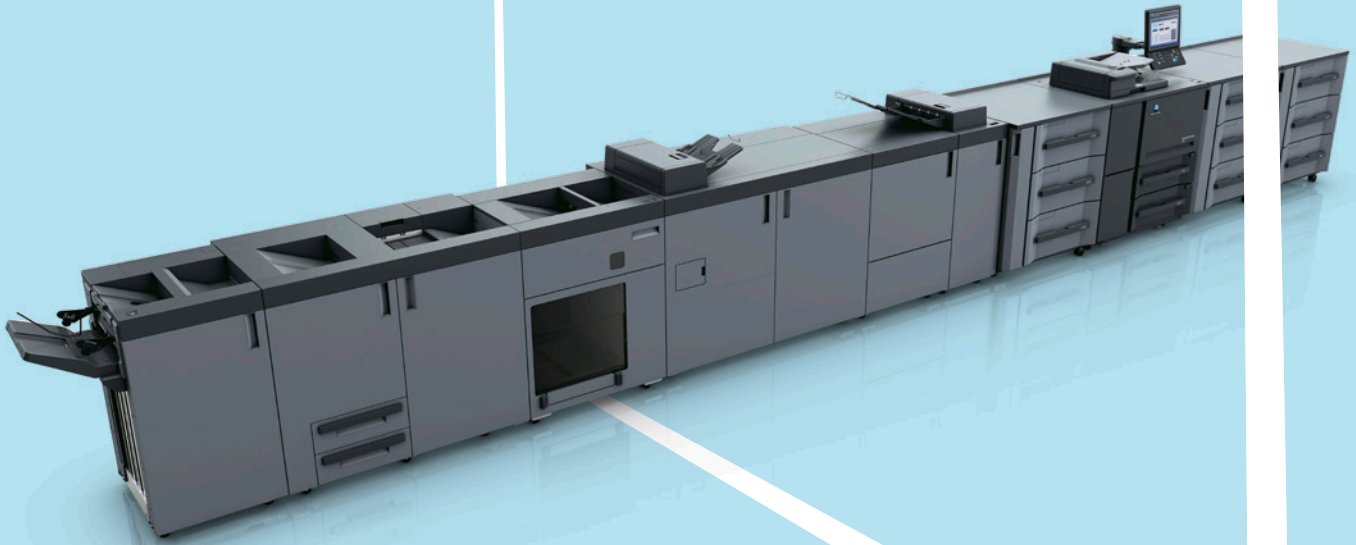

Giving Shape to Ideas

ACCELERATE YOUR BUSINESS WITH AccurioPress SYSTEMS

To stay in the black, your business needs to stay productive. The AccurioPress 7136 series is all you need for Smart Factory printing at speed. Optimise your print production planning and maximise the profitability of your mid-volume print environment with these next generation systems. Built on almost 20 years of expertise in print production the AccurioPress 7136 series knows what you need, integrating seamlessly with your workflow. Better still, it connects easily with your service and business platforms – whether they're on site or in the cloud.

Exceptional print quality every time

Its exclusive Intelligent Quality Optimizer IQ-501 leverages Konica Minolta's long history of brilliant imaging technology allowing you to wow your customers with stunningly consistent prints, time and time again.

Grow your business

Our mission is to empower you to grow your business with our solutions. The AccurioPress 7136/7136P/7120 is a great example, helping you with its extensive variety of supported media, from thin to thick paper (up to 350 g/m²) including envelopes. What's more, our stock library provides a stack of media profiling capabilities to ensure you can always access the right setting for the best available output.

Intelligent Automation

The optional IQ-501 Intelligent Quality Care Unit ensures you get perfectly consistent colour quality and front-to-back registration on every print, in real-time. And because there are no recalibrations or inspections mid-run, you'll benefit from improved productivity too.

Boost your operational efficiency

Our new generation of true production systems has been designed to increase the uptime of your press and print, saving you time. Their range of new features lets you produce more higher-value print products more quickly. By pairing your AccurioPress 7136/7136P/7120 with one of more of our professional in-line finishers – such as booklet making, punching or binding – you can enhance your productivity to the maximum.

10

Andante

30

pp 3 5

1 2 1(8) 4 8(5)

2 1 2 4 5 2 4 1 5 2 4

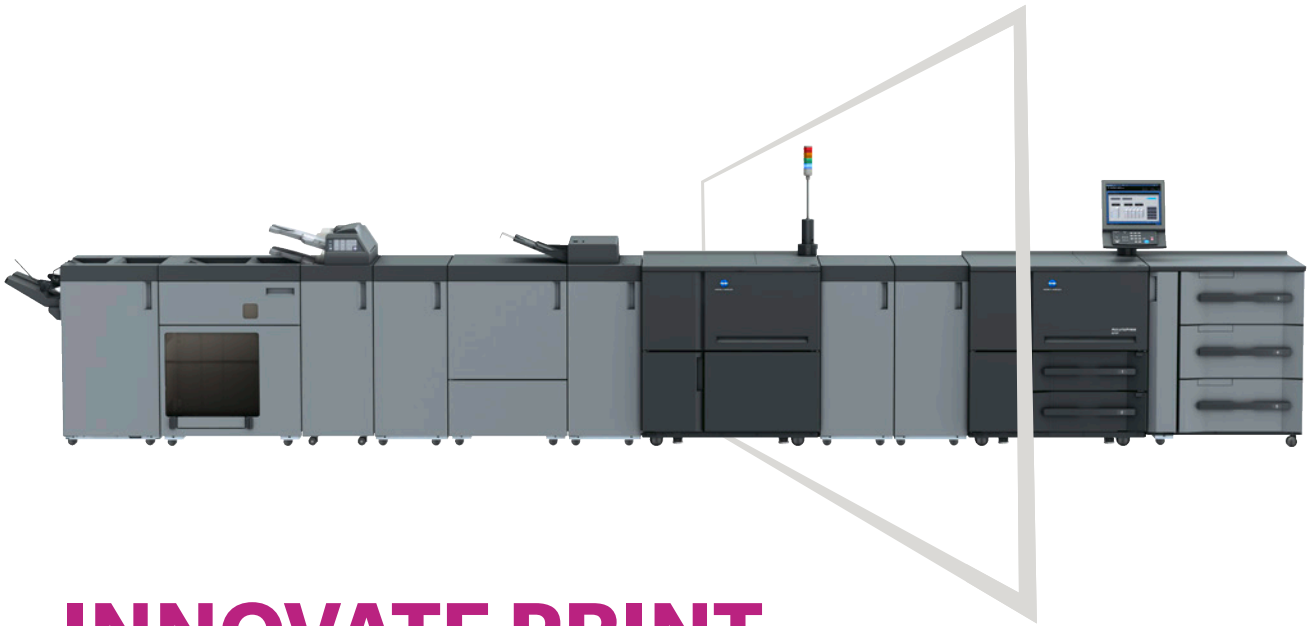

INNOVATE PRINT

RETHINK TECHNOLOGY

S.E.A.D. IMAGE PROCESSING

Konica Minolta's own advanced colour processing technology of the second generation is called S.E.A.D., which stands for "Screen-Enhancing Active Digital Process" and combines an array of technical innovations to guarantee truly exceptional colour reproduction at top speed. S.E.A.D. includes these important capabilities:

SIMITRI HD TONER

The extremely small size and uniform shape of ultra-fine Simitri® HD toner particles assure highest image quality as well as razor-sharp reproduction of text and line drawings. Simitri® HD unfailingly delivers consistently excellent image output quality on par with offset quality.

Simitri HD
High Definition Polymerised Toner

MEDIA DETECTION SENSOR

The optional media sensor IM-101 automatically detects the type, weight, thickness and surface of each substrate, and proposes the appropriate paper settings from the catalogue, which makes wrong

paper settings a thing of the past avoiding misprints and waste. About 220 paper profiles are pre-registered in the catalogue making sure always finding a good match

INTELLIGENT QUALITY CARE UNIT

An automatic mode enables even unskilled operators to make simple and straightforward adjustments to density and front-to-back registration in no time, facilitating the continuous production of prints in highest quality.

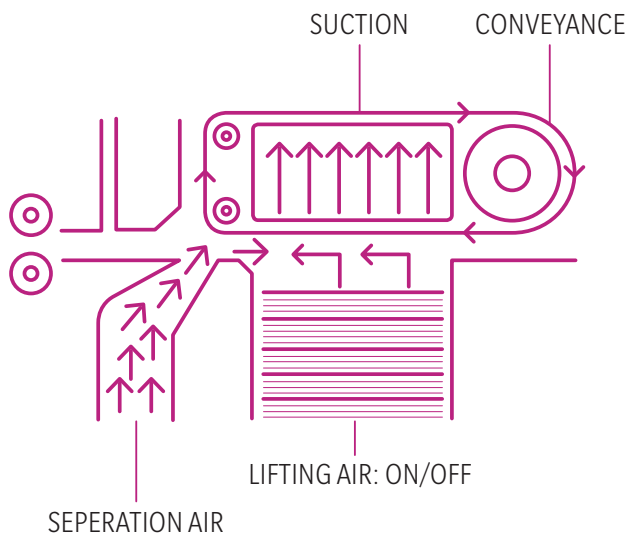

VACUUM PAPER FEEDING

For high-volume printers, feeding each and every sheet smoothly and precisely through the digital press is an essential requirement. To ensure this, Konica Minolta offers professional and intelligent paper feeding that builds upon proven concepts, including a combination of air separation of sheets and suction/vacuum feeding. This ensures smooth paper processing throughout the printing system. For efficient printing on offset preprinted and coated stock as well as under conditions of high humidity, an optional heating unit can be added to enhance this precise technology further.





POWERFUL PRINT SERVER

RETHINK YOUR USER EXPERIENCE

MIC-4160 FIERY CONTROLLER

Reduce labour costs, cut turnaround times, and minimise errors and paper waste with the advanced job management and workflow automation that the MIC-4160 provides. Streamline your job layout with the Fiery's instant visual preview and advanced ready-made capabilities. What's more, by supporting industry leading variable data printing (VDP) formats, the Fiery also produces personalised short-run jobs profitably.

MIC-4170 FIERY CONTROLLER

Produce high value, complex applications with superior image quality to maximise your profitability. The top-of-the-line Fiery® MIC-4170 will improve your bottom line with best-in-class processing, outstanding quality and time-saving workflows. Automate job preparation steps in prepress workflows to produce ready-to-print files with Fiery JobFlow™ Base. This easy-to-use automation software increases productivity and reduces costs.

KONICA MINOLTA OWN CONTROLLER

The Konica Minolta controller comes with powerful workflow benefits printing at full rated engine speed, highspeed RIP processing, enhanced accuracy in colour reproduction, various colour management functions as well as full compatibility with print engine on-board job control and editing functions.

Functions And Features

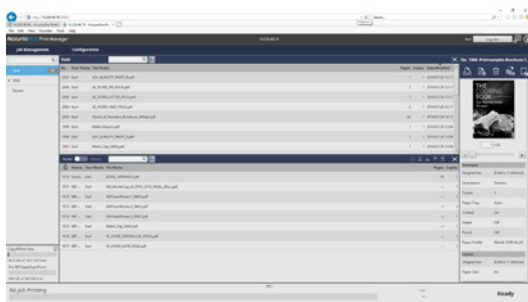

Queue management

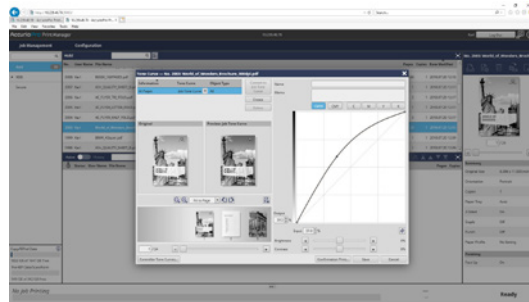

Tone curve utility

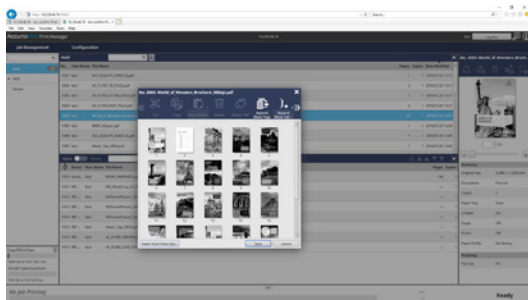

Page editing

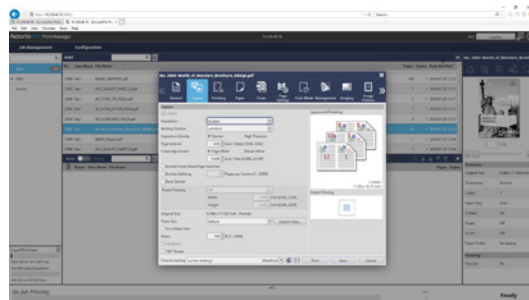

Job properties





STREAMLINE YOUR PRODUCTION

RETHINK YOUR WORKFLOW

Evolving from our expertise in precision technologies and more than 80 years of experience in the printing and imaging industries, AccurioPro reflects our commitment to developing market-shaping technology with functionality that enables your business to grow. AccurioPro, Konica Minolta's suite of digital solutions for professional printing, is one of the industry's most versatile and powerful tools to optimise print production operations and workflows.

For all printing companies looking to integrate their printing as well as businesses that use digital printing to produce their own in-house publications and

promotional materials, AccurioPro boosts speed and efficiency, expands capabilities and services, and reduces the need for operational manpower – all of which will help improve your profitability!

The comprehensive suite of features that AccurioPro offers includes centralised management, software for automated workflow processing, colour management, seamless integration of different printing technologies and full connectivity of all Konica Minolta printing systems used from input to output.

AccurioPro POSSIBILITIES RETHINK YOUR WORKFLOW

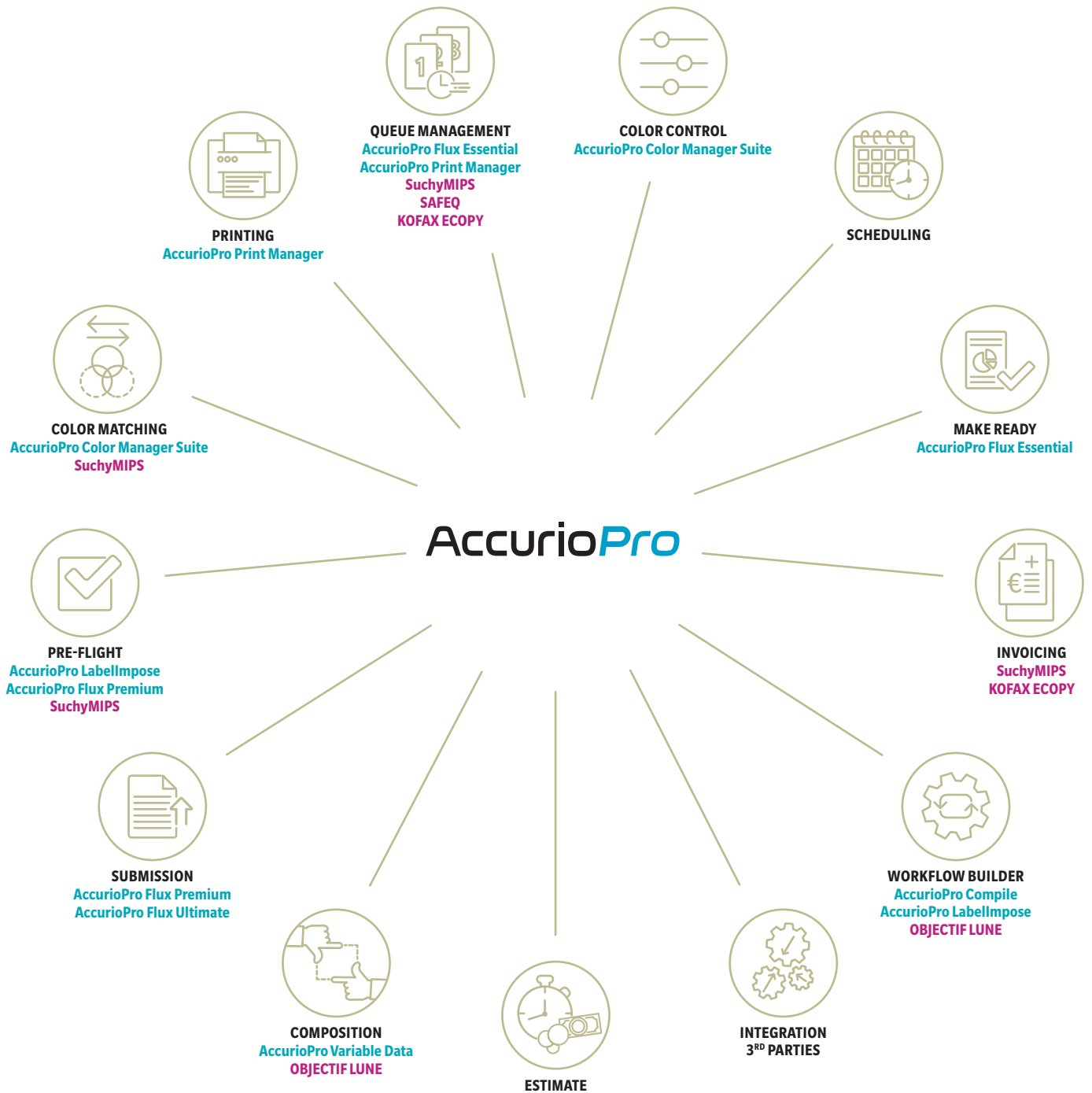

YOUR ADVANTAGES WITH THE AccurioPress 7136

RETHINK MONOCHROME PRINT PRODUCTION

READY-MADE PRINT PRODUCTS

- 50-sheet booklet making with front trimming and optional creasing, slitting and spine corner forming
- Perfect binding for books of up to 30 mm
- 100-sheet stapling with cutting mechanism
- 102-sheet auto ring binding
- Automated inline business card and postcard cutting
- Full bleed A3 and A4 posters

DURABLE PERFORMANCE

AccurioPress 7136/7136P

- Duty Cycle up to 3.24 million prints
- Up to 136 A4 pages per minute
- Up to 74 SRA3 pages per minute

AccurioPress 7120

- Duty Cycle up to 2.5 million prints
- Up to 120 A4 pages per minute
- Up to 66 SRA3 pages per minute

HIGHEST RELIABILITY

- Long-life platform, long-lasting parts and consumables
- Optimal registration results via ICCU
- Belt transfer system
- For prints with maximum efficiency
- For lucrative short-run printing

GEARED-UP FINISHING

- Multi (GBC) punching and 2- & 4-hole punching
- 6 different types of folding
- 3rd-party Products
- Large-capacity stacking
- 2 Perforations in feed direction, 5 Perforations in Cross feed direction
- Up to 5 Creases downwards or upwards

SIMPLY EFFICIENT

- Automated engine linearisation
- Automated duplex registration
- Automated profiling
- Real-time adjustments
- Purge function



HIGH-END PRINT CONTROL

- Flexible choice of controller technology: Fiery or Konica Minolta Controller
- Integration into hybrid workflows

EASE OF USE

- Auto Inspection Technology
- About 220 paper profiles loaded as standard
- Optional Intelligent Media Sensor IM-101 to detect type and weight of the paper
- Unified user interface among Konica Minolta engines

PERFECT IMAGE QUALITY

- 1,200 x 1,200 dpi print resolution
- Tone Curve Utility
- S.E.A.D. Technology
- Simitri HD Toner Technology

SOPHISTICATED MEDIA HANDLING

- Air suction feeding technology
- Up to 18,000 sheets paper feeding from 11 trays
- Pre-set paper catalog

COMPREHENSIVE MEDIA PROCESSING

- Paper weights from 40 – 350 gsm in simplex and up to 300 gsm in duplex printing
- Optional heating units to support preprinted paper
- Envelop printing as standard
- Optional inter-cooler and eliminator

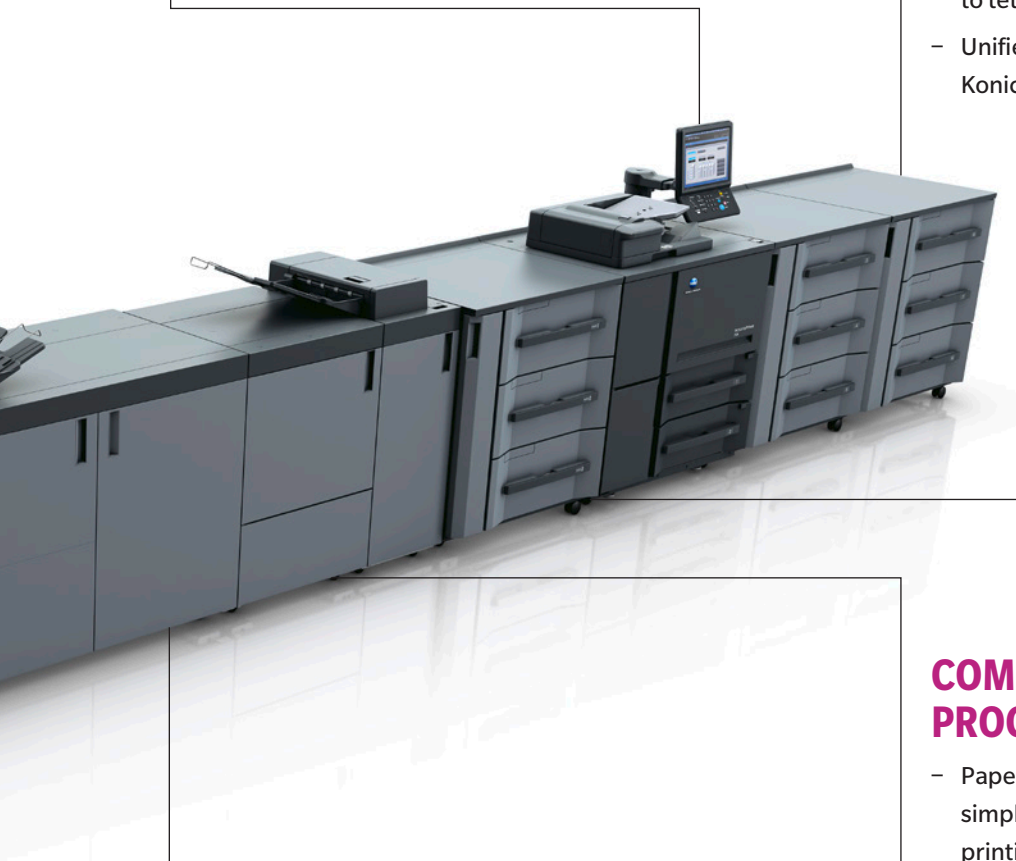

FINISHING & FUNCTIONS



Letter fold



2/4 hole Punching



Two-point stapling



Corner stapling



Stacking



































Booklet



Trimming

Open stacker OT-512								
Ring binding unit MB-200 Max Finisher								
Staple finisher FS-532/541								
Booklet making unit SD-513								
Stacking unit LS-507								
Folding and punching unit FD-503								
Perfect binding unit PB-503								
Booklet making unit SD-506								
Trimming unit TU-510								
Booklet making unit Plockmatic SD-435/450								
Booklet making unit PSQ-224								
Ring binding unit GBC G1								
Multi punching unit GBC G3								

	 Creasing	 Slitting	 Perforation	 Square-folding	 Multi Letter fold-In	 Post Insertion	 Perfect Binding	 Wire-binding	 Ring-binding	 Multi-punching	
											ENTRY
											
											MID
											
											
											
											HIGH
											
											
											





10 GOOD REASONS TO CHOOSE THE AccurioPress 7136 series



1. PERFECT IMAGE QUALITY

with Konica Minolta's own imaging technology and toner development.

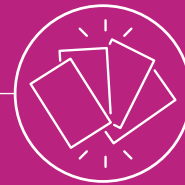

2. OUTSTANDING PAPER COMPATIBILITY

for media from 40 to 350gsm. Excellent paper feeding options plus de-curling and paper cooling as standard.



3. VERSATILE CONFIGURATIONS

with over 700 ways to set up your press.



4. BENEFIT FROM GREAT BUILT-IN TECHNOLOGIES

such as the latest screening and registration.



5. SHORT TURNAROUNDS

thanks to workflow automation options.



6. INCREASE UPTIME

with automated and time reduced set up times.



7. IMPROVE YOUR CUSTOMER LOYALTY

with auto quality measures to meet expectations.



8. MORE JOBS IN THE SHOP

with ready-made print products, geared-up finishing and a variety of in-line solutions.



9. AUTOMATED FINISHING

with many unique in-line options to create ready-to-ship booklets, perfectly bound books, ring or wire bound books and much more.



10. COMPLIANCE

with global environmental standards.

TAKE LEADERSHIP AND RESPONSIBILITY

RETHINK TOMORROW'S BUSINESS

MADE FOR YOUR BUSINESS

Commercial printers

Growing your business and getting the maximum out of your investment is what the AccurioPress 7136 series promises. The high speed, high productivity and high uptime help you achieve shortest turnaround times. Combined with great media flexibility with stocks of up to 350 g/m², you further enhance the offerings of your print shop. Quality issues are a thing of the past, as these presses offer a wide range of tools to control and adjust themselves.

CRDs

AccurioPress 7136 series support a high degree of automation and yet also ensure high-level quality. Professional inline finishing produces ready-made print products at the click of a finger. Their versatile media flexibility and high productivity make AccurioPress 7136/7136P/7120 a solid and lucrative investment for the future.

DESIGNING FOR TOMORROW

At Konica Minolta, we're committed to sustainable development at every stage of the product life cycle. In fact, as part of the 50 Climate Leaders initiative, we've joined forces with some of the world's biggest manufacturing companies to help combat climate change. We offset all emissions produced by the manufacturing and transportation of our products and we can work with you to offset any unavoidable CO₂ emissions resulting from your production printing. And once you've finished with any of our products, we offer a high-quality returns and recycling service - reducing waste, increasing efficiency, and helping to preserve the earth's natural resources for tomorrow.





CONTROLLER AND OPTIONS

RETHINK THE NEEDS

KONICA MINOLTA CONTROLLER

Type	Built-in type
Resolution	Print: 1,200 x 1,200 dpi; 600 dpi x 600 dpi
CPU	Intel i5 6500 3.2 GHz
Memory	16 GB
HDD	2x 1TB
SSD	4 GB
Interface	Ethernet 10/100/1000BASE-T; USB 3.0 (for direct print, service) USB 2.0 (for local print)
Page-description language	PCL5E/XL (PCL6); Adobe PostScript 3 (PS3020); PDF directprint (PDF Ver. 1.7); TIFF (TIFF Ver.6) direct print; PPML (Ver 2.2), APPE (Ver. 4.6, UK-217 required)

FIERY IMAGE CONTROLLER MIC-4160

Architecture	External
OS	Windows 10
CPU	Intel Pentium Gold G5400
Clock speed	3.7 GHz
RAM	8 GB (2x 4 GB)
HDD	500 GB, SSD boot driver for OS and Fiery software
Page-description language	Adobe PostScript 3; PDF v1.7; APPE v5.5; PDF/VT-1/-2 v3; PDF/X1a,3,4; PPML v3.0; PCL; Creo VPS; Applicable OS Windows 8.1/10; Windows Server 2012/R2/2016/2019; Mac OS X 10.11-14

FIERY IMAGE CONTROLLER MIC-4170

Architecture	External
OS	Windows 10
CPU	i5-8500 processor
Clock speed	3.2 GHz
RAM	8GB (2x4GB)
HDD	1TB, SSD boot driver for OS and Fiery software
Page-description language	Adobe PostScript 3; PDF v1.7; APPE v5.5; PDF/VT-1/-2 v3; PDF/X1a,3,4; PPML v3.0; PCL; Creo VPS; Applicable OS Windows 8.1/10; Windows Server 2012/R2/2016/2019; Mac OS X 10.11-14

OPTIONS

Air assist paper feed unit	PF-709
Pre-printed paper feed kit for PF-706	PP-701
Air-assist paper feed unit	PF-710
Heating unit for PF-710	HT-506
Post insertion unit	PI-PFU
Relay unit	RU-518m
Humidification unit	HM-103
Integrated Color Care unit	IQ-501
Purge Unit	RU-702
Auto Inspection Unit	UK-301
Envelop Fusing Unit	EF-109
Intelligent Media Sensor	IM-101
Relay unit	RU-510
Folding and punching unit	FD-503
Stacking unit	LS-507
Booklet making unit	SD-506
Booklet making unit	SD-513
Creasing unit for SD-513	CR-101
Slitting unit for SD-513	TU-503
Spine corner forming unit for SD-513	FD-504
Perfect binding unit	PB-503
Stapling unit	FS-532m
Stapling unit	FS-541
Saddle stitch kit for FS-532m /FS-541	SD-510
Punch kit for FS-532m/FS-541	PK-525
Post inserter for FS-532m /FS-541	PI-502
Open stacker	OT-512
Trimmer Unit	TU-510
Creaser kit (Downwards)	CR-102
Creaser kit (Upwards)	CR-103
Trimmer kit	TU-504
Business Card Unit	JS-507
Perforation kit Horizontal	PE-101
Perforation kit Vertical	PE-102
Scrap ejection kit	MK-765
Mount kit for 3rd-party options	MK-737
GBC Punch	G3
GBC Wire Binder	G1
Max Binder	MB-200
Plockmatic	PowerSquare™ 224KR
Plockmatic	SD-450/SD-435



CAUTION
OVERTOW SWITCH
STAY CLEAR

866-103
413R

STRAP INSTALLATION



GOOD YEAR
EIGHT LEADERS
NITROGEN INFLATION ONLY
160-1-OR
160-1-OR



KONICA MINOLTA

TECHNICAL SPECIFICATIONS

RETHINK INNOVATION

SYSTEM SPECIFICATIONS

Resolution	1,200 x 1,200 dpi
Paper weight	40–350 g/m ²
Paper sizes	Min.: 95 x 139 mm Max.: 324 x 483 mm (with PF-710)
Paper input capacity	Max.: 18,000 sheets
Main unit dimensions (W x D x H)	990 x 910 x 1,454 mm
Main unit weight	369 kg (AccurioPress 7136/7120) 345 kg (AccurioPress 7136P)

- All specifications refer to A4-size paper of 80 g/m² quality.
- The support and availability of the listed specifications and functionalities vary depending on operating systems, applications and network protocols as well as network and system configurations.
- The stated life expectancy of each consumable is based on specific operating conditions such as page coverage for a particular page size (5 % coverage of A4).
- The actual life of each consumable will vary depending on use and other printing variables including page coverage, page size, media type, continuous or intermittent printing, ambient temperature and humidity.
- Some of the product illustrations contain optional accessories.
- Specifications and accessories are based on the information available at the time of printing and are subject to change without notice.
- Konica Minolta does not warrant that any prices or specifications mentioned will be error-free.
- All brand and product names may be registered trademarks or trademarks of their respective holders and are hereby acknowledged.

PRODUCTIVITY

AccurioPress 7136/7136P

A4 – max. per minute	136 ppm
A3 – max. per minute	78 ppm
SRA3 – max. per minute	74 ppm
A4 – max. per hour	7,940 ppm
A3 – max. per hour	4,526 pph
SRA3 – max. per hour	4,274 pph

PRODUCTIVITY

AccurioPress 7120

A4 – max. per minute	120 ppm
A3 – max. per minute	70 ppm
SRA3 – max. per minute	66 ppm
A4 – max. per hour	7,034 pph
A3 – max. per hour	4,072 pph
SRA3 – max. per hour	3,846 pph